

# Amp Champ™ LED Tape Light & Wire Connector

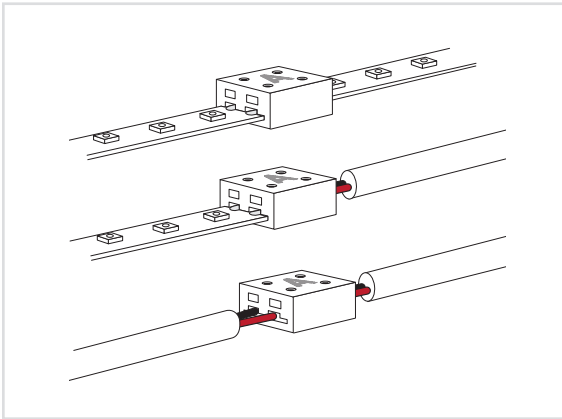

The compact, capable, safe, and versatile Amp Champ LED tape light and wire connector provides secure connections between LED tape light sections, between tape light and wire, or between pairs of wire leads. Amp Champ fits easily into many aluminum channels with diffusers. Pre-installed 3M VHB tape provides an excellent strain relief.

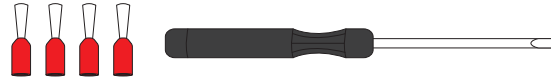

Each connector includes 4 spade connectors for use with stranded wire, a mini screwdriver, and one pre-installed piece of six-inch CL2 wire with tinned leads at each end.

## TECHNICAL INFORMATION

<b>Voltage</b>	12-24V DC
<b>Max. Current</b>	8A*
<b>Mounting</b>	3M™ VHB tape (pre-installed)
<b>Max. Wire Gauge</b>	16 AWG
<b>Compatible Wire</b>	Solid core, tinned, stranded

\*For Class 2 compliance, circuits are limited to 5A (12V) and 4A (24V).  
 Note: Pre-installed 3M VHB tape adds approximately 0.04 in. in height. 3M VHB tapes can be removed if tape light does not fit into channel.

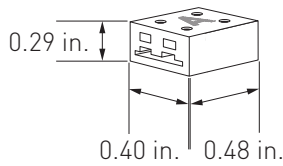

AL-01-01-9900  
 AL-01-02-9900  
 AL-01-51-9900

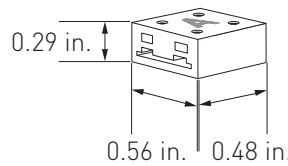

AL-01-04-9900  
 AL-01-05-9900  
 AL-01-79-9900  
 AL-01-80-9900  
 AL-01-81-9900  
 AL-01-82-9900

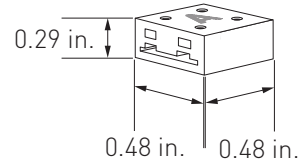

AL-01-07-9900  
 AL-01-08-9900  
 AL-01-15-9900  
 AL-01-16-9900  
 AL-01-19-9900

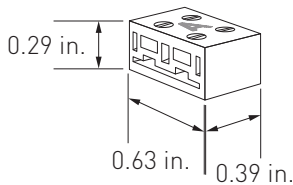

AL-01-18-9900

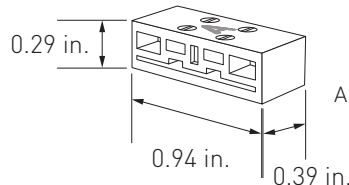

AL-01-20-9900

## PRODUCT INFORMATION

---

**Add "-10" to the end of the item # for a 10 pack**

Item #	Compatible Tape Light	Dimensions (W x L x H)
AL-01-01-9900	PrimaLine 1.5	0.4 x 0.48 x 0.29 in.
AL-01-02-9900	PrimaLine 3	0.4 x 0.48 x 0.29 in.
AL-01-51-9900	PrimaLine 3 SE	0.4 x 0.48 x 0.29 in.
AL-01-04-9900	PrimaLine 1.5 XT	0.56 x 0.48 x 0.29 in.
AL-01-05-9900	PrimaLine 3 XT	0.56 x 0.48 x 0.29 in.
AL-01-07-9900	PrimaLine 5.5 LP	0.48 x 0.48 x 0.29 in.
AL-01-08-9900	PrimaLine 2.7 LP	0.48 x 0.48 x 0.29 in.
AL-01-15-9900	PrimaLine 4.4 Gen 2	0.48 x 0.48 x 0.29 in.
AL-01-16-9900	PrimaLine 4.4 XT Gen 2	0.48 x 0.48 x 0.29 in.
AL-01-18-9900	PrimaLine 6.6 Gen 2	0.63 x 0.39 x 0.29 in.
AL-01-19-9900	PrimaLine 7	0.48 x 0.48 x 0.29 in.
AL-01-20-9900	PrimaLine 8 Gen 2	0.94 x 0.39 x 0.29 in.
AL-01-79-9900	Varien 1.2 XT	0.56 x 0.48 x 0.29 in.
AL-01-80-9900	Varien 2.7	0.56 x 0.48 x 0.29 in.
AL-01-81-9900	Varien 5.5	0.56 x 0.48 x 0.29 in.
AL-01-82-9900	Varien 8	0.56 x 0.48 x 0.29 in.

## INSTRUCTIONS

NOTE: Check polarity of the tape light and/or wires: (+) and (-) symbols on the tape should match POSITIVE (red) and NEGATIVE (black) wires.  
 NOTE: Ensure all components are installed in accordance with the current National Electric Code (NEC), and UL safety standards.

### Connecting Standard Tape Light

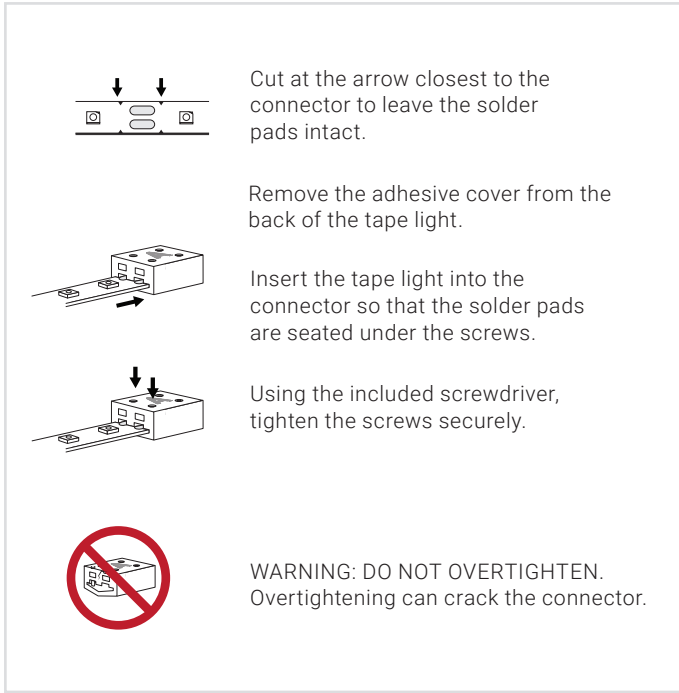

Cut at the arrow closest to the connector to leave the solder pads intact.

Remove the adhesive cover from the back of the tape light.

Insert the tape light into the connector so that the solder pads are seated under the screws.

Using the included screwdriver, tighten the screws securely.

**WARNING: DO NOT OVERTIGHTEN.**  
Overtightening can crack the connector.

### Connecting Low-Profile Tape Lights

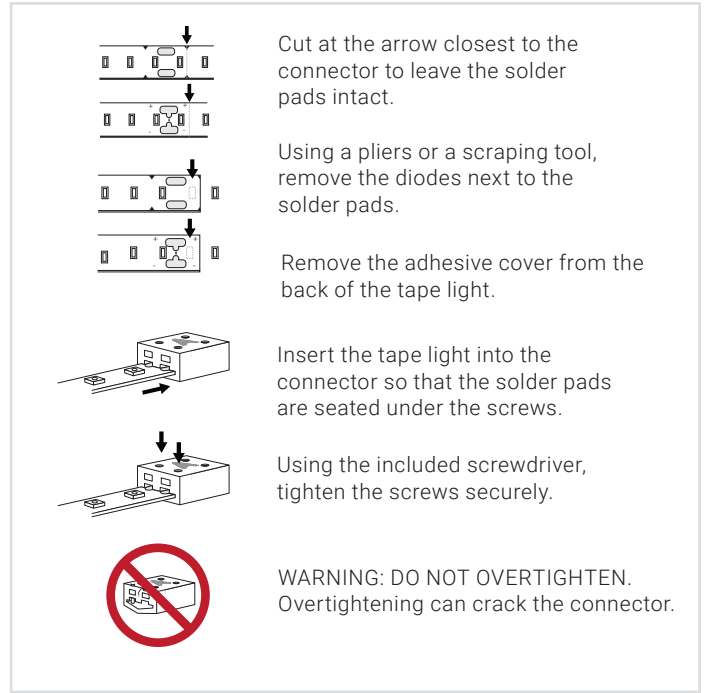

Cut at the arrow closest to the connector to leave the solder pads intact.

Using a pliers or a scraping tool, remove the diodes next to the solder pads.

Remove the adhesive cover from the back of the tape light.

Insert the tape light into the connector so that the solder pads are seated under the screws.

Using the included screwdriver, tighten the screws securely.

**WARNING: DO NOT OVERTIGHTEN.**  
Overtightening can crack the connector.

### Connecting Wire

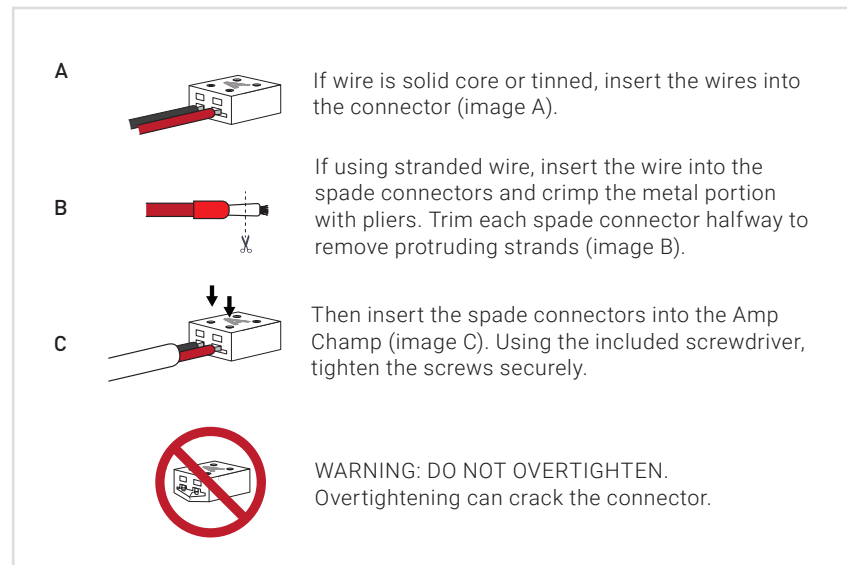

**A** If wire is solid core or tinned, insert the wires into the connector (image A).

**B** If using stranded wire, insert the wire into the spade connectors and crimp the metal portion with pliers. Trim each spade connector halfway to remove protruding strands (image B).

**C** Then insert the spade connectors into the Amp Champ (image C). Using the included screwdriver, tighten the screws securely.

**WARNING: DO NOT OVERTIGHTEN.**  
Overtightening can crack the connector.

## CONFIGURATIONS

Tape to Hard-Wired Power Connection

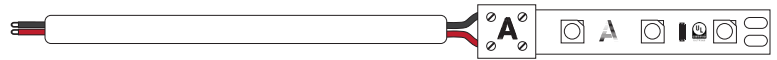

Tape-to-Tape Connection



Flexible Jumper Connection

\*Two Amp Champs Required

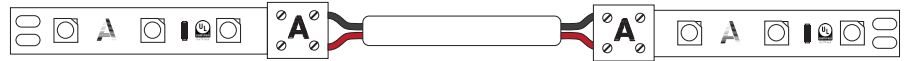

Tape to DC Plug Connection



Wire to Wire Connection



Note: RGB Amp Champs model has 4 screws and RGB-W Amp Champs model has 5 screws for wiring instead of the standard 2 screws.

## AMP CHAMP & CHANNEL COMPATIBILITY

	Polymer Low-Profile Surface Mount	Surfa 1	Surfa 2	Surfa 2X	Surfa 3	Surfa 6	Surfa 7	Suspan® 1	Ankr® 1	Ankr® 2	Ankr® 3	Ankr® 4	Naro® 4	Duro 1	Duro 2
PrimaLine® 1.5	Y		Y	Y		Y	Y	Y	Y	Y	Y	Y	Y	Y	Y
PrimaLine 1.5 XT	Y			Y		Y		Y	Y	Y			Y		
PrimaLine 2.7 LP	Y			Y		Y	Y	Y	Y	Y	Y	Y	Y		
PrimaLine 3	Y		Y	Y		Y	Y	Y	Y	Y	Y	Y	Y	Y	Y
PrimaLine 3 XT	Y			Y		Y		Y	Y	Y			Y		
PrimaLine 4.4 Gen 2	Y			Y		Y	Y	Y	Y	Y	Y	Y	Y		
PrimaLine 4.4 XT Gen 2	Y			Y		Y	Y	Y	Y	Y	Y	Y	Y		
PrimaLine 5.5 LP	Y			Y		Y	Y	Y	Y	Y	Y	Y	Y		
PrimaLine 6.6 Gen 2	Y			Y		Y		Y	Y	Y			Y		
PrimaLine 7	Y			Y		Y	Y	Y	Y	Y	Y	Y	Y		
PrimaLine 8 Gen 2				Y				Y	Y	Y					
Varien 1.2 XT Dim-to-Warm	Y			Y		Y		Y	Y	Y			Y		
Varien 2.7 Dim-to-Warm	Y			Y		Y		Y	Y	Y			Y		
Varien 5.5 Dim-to-Warm	Y			Y		Y		Y	Y	Y			Y		
Varien 8 Dim-to-Warm	Y			Y		Y		Y	Y	Y			Y		

Note: 3M VHB tape under Amp Champ is removable. Data from the chart is measured without the tape.

# Amp Champ™ LED Tape Light & Wire Corner Connector

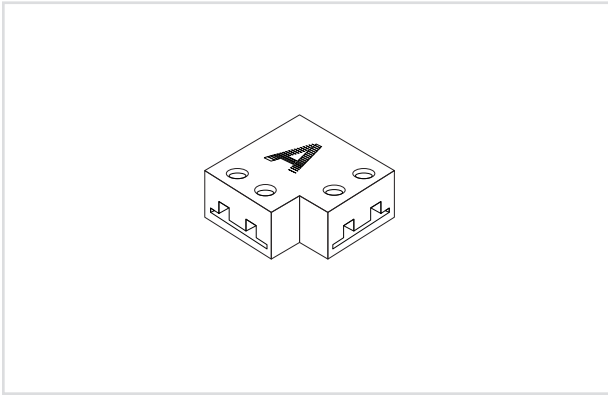

The compact, capable, safe, and versatile Amp Champ LED tape light and wire connector provides secure connections between LED tape light sections, between tape light and wire, or between pairs of wire leads. Amp Champ fits easily into many aluminum channels with diffusers. Pre-installed 3M VHB tape provides an excellent strain relief.



Each connector includes (4) spade connectors for use with stranded wire, and a mini screwdriver.

## TECHNICAL INFORMATION

<b>Voltage</b>	12-24V DC
<b>Max. Current</b>	8A*
<b>Mounting</b>	3M™ VHB tape (pre-installed)
<b>Max. Wire Gauge</b>	16 AWG
<b>Compatible Wire</b>	Solid core, tinned, stranded

\*For Class 2 compliance, circuits are limited to 5A (12V) and 4A (24V).

Note: Pre-installed 3M VHB tape adds approximately 0.04 in. in height.  
3M VHB tapes can be removed if tape light does not fit into channel.

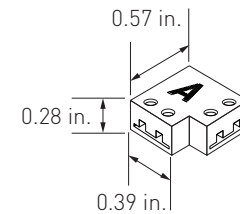

AL-01-01-9900-L  
AL-01-02-9900-L  
AL-01-51-9900-L

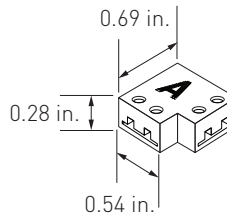

AL-01-04-9900-L  
AL-01-05-9900-L  
AL-01-81-9900-L

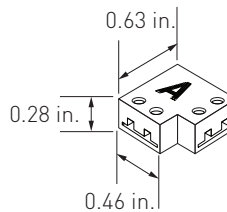

AL-01-07-9900-L  
AL-01-08-9900-L  
AL-01-15-9900-L  
AL-01-16-9900-L

## PRODUCT INFORMATION

Item #	Compatible Tape Light	Dimensions (W x L x H)
AL-01-01-9900-L	PrimaLine 1.5	0.39 x 0.57 x 0.28 in.
AL-01-02-9900-L	PrimaLine 3	0.39 x 0.57 x 0.28 in.
AL-01-51-9900-L	PrimaLine 3 SE	0.39 x 0.57 x 0.28 in.
AL-01-04-9900-L	PrimaLine 1.5 XT	0.54 x 0.69 x 0.28 in.
AL-01-05-9900-L	PrimaLine 3 XT	0.54 x 0.69 x 0.28 in.
AL-01-07-9900-L	PrimaLine 5.5 LP	0.46 x 0.63 x 0.28 in.
AL-01-08-9900-L	PrimaLine 2.7 LP	0.46 x 0.63 x 0.28 in.
AL-01-15-9900-L	PrimaLine 4.4 Gen 2	0.46 x 0.63 x 0.28 in.
AL-01-16-9900-L	PrimaLine 4.4 XT Gen 2	0.46 x 0.63 x 0.28 in.
AL-01-81-9900-L	Varien 5.5	0.54 x 0.69 x 0.28 in.

## INSTRUCTIONS

NOTE: Check polarity of the tape light and/or wires: (+) and (-) symbols on the tape should match POSITIVE (red) and NEGATIVE (black) wires.  
 NOTE: Ensure all components are installed in accordance with the current National Electric Code (NEC), and UL safety standards.

### Connecting Standard Tape Light

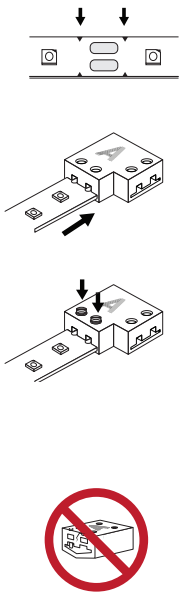

Cut at the arrow closest to the connector to leave the solder pads intact.

Insert the tape light into the connector so that the solder pads are seated under the screws.

Using the included screwdriver, tighten the screws securely.

**WARNING: DO NOT OVERTIGHTEN.**  
Overtightening can crack the connector.

### Connecting Low-Profile Tape Lights

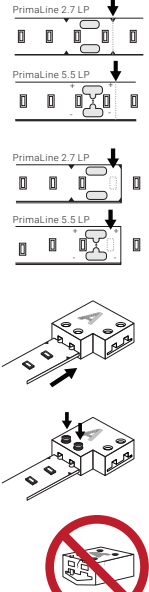

Cut at the arrow closest to the connector to leave the solder pads intact.

Using pliers or a scraping tool, remove the diode closest to the cut edge.

Insert the tape light into the connector so that the solder pads are seated under the screws.

Using the included screwdriver, tighten the screws securely.

**WARNING: DO NOT OVERTIGHTEN.**  
Overtightening can crack the connector.

### Connecting Wire

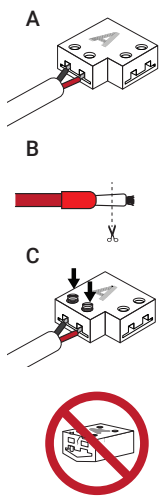

**A** If wire is solid core or tinned, insert the wires into the connector (image A).

**B** If using stranded wire, insert the wire into the spade connectors and crimp the metal portion with pliers. Trim each spade connector halfway to remove protruding strands (image B).

**C** Then insert the spade connectors into the Amp Champ (image C). Using the included screwdriver, tighten the screws securely.

**WARNING: DO NOT OVERTIGHTEN.**  
Overtightening can crack the connector.

## CONFIGURATIONS

---

### Tape to Hard-Wired Power Connection

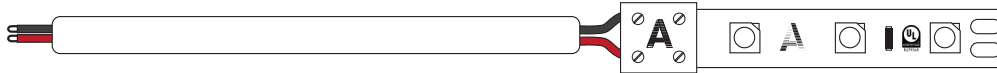

### Tape-to-Tape Connection



### Flexible Jumper Connection \*Two Amp Champs Required

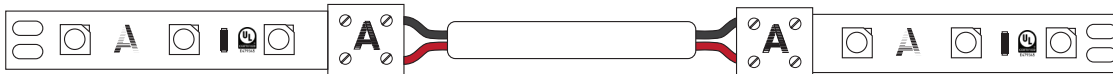

### Tape to DC Plug Connection

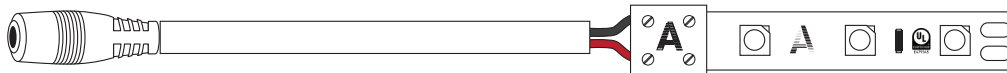

### Wire to Wire Connection



## AMP CHAMP & CHANNEL COMPATIBILITY

	Polymer Low-Profile Surface Mount	Surfa 1	Surfa 2	Surfa 2X	Surfa 3	Surfa 6	Surfa 7	Suspan <sup>®</sup> 1	Ankr <sup>®</sup> 1	Ankr <sup>®</sup> 2	Ankr <sup>®</sup> 3	Ankr <sup>®</sup> 4	Naro <sup>®</sup> 4	Duro 1	Duro 2
PrimaLine <sup>®</sup> 1.5	Y		Y	Y		Y	Y	Y	Y	Y	Y	Y	Y	Y	Y
PrimaLine 1.5 XT	Y			Y		Y	Y	Y	Y	Y	Y	Y	Y		
PrimaLine 2.7 LP	Y			Y		Y	Y	Y	Y	Y	Y	Y	Y		
PrimaLine 3	Y		Y	Y		Y	Y	Y	Y	Y	Y	Y	Y	Y	Y
PrimaLine 3 XT	Y			Y		Y	Y	Y	Y	Y	Y	Y	Y		
PrimaLine 4.4 Gen 2	Y			Y		Y	Y	Y	Y	Y	Y	Y	Y		
PrimaLine 4.4 XT Gen 2	Y			Y		Y	Y	Y	Y	Y	Y	Y	Y		
PrimaLine 5.5 LP	Y			Y		Y	Y	Y	Y	Y	Y	Y	Y		

Note: 3M VHB tape under Amp Champ is removable. Data from the chart is measured without the tape.



# Amp Champ™ LED Tape Light & Wire Up/Down Connector

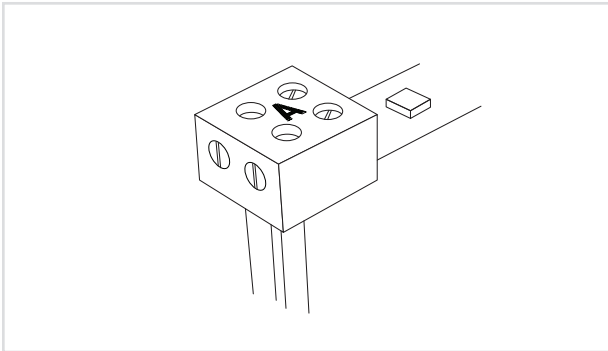

The compact, capable, safe, and versatile Amp Champ LED tape light connector provides secure connections between LED tape light and wire leads. Amp Champ fits easily into many aluminum channels with diffusers.



Each connector includes a mini screwdriver and one pre-installed piece of six-inch CL2 wire with tinned leads at one end.

## TECHNICAL INFORMATION

<b>Voltage</b>	12-24V DC
<b>Max. Current</b>	8A*
<b>Max. Wire Gauge</b>	16 AWG
<b>Compatible Wire</b>	Solid core, tinned, stranded

\*For Class 2 compliance, circuits are limited to 5A (12V) and 4A (24V).

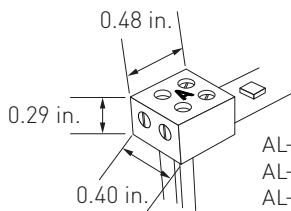

AL-01-01-9900-UD  
AL-01-02-9900-UD  
AL-01-51-9900-UD

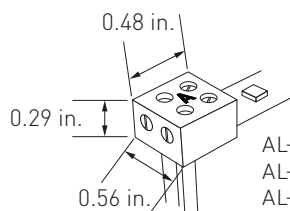

AL-01-04-9900-UD  
AL-01-05-9900-UD  
AL-01-79-9900-UD  
AL-01-80-9900-UD  
AL-01-81-9900-UD  
AL-01-82-9900-UD

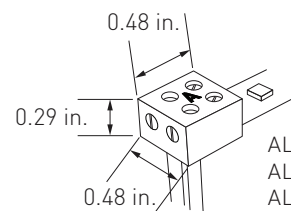

AL-01-07-9900-UD  
AL-01-08-9900-UD  
AL-01-15-9900-UD  
AL-01-16-9900-UD  
AL-01-19-9900-UD

## PRODUCT INFORMATION

Add "-10" to the end of the Item # for a 10 pack

Item #	Compatible Tape Light	Dimensions (W x L x H)	Item #	Compatible Tape Light	Dimensions (W x L x H)
AL-01-01-9900-UD	PrimaLine 1.5	0.4 x 0.48 x 0.29 in.	AL-01-19-9900-UD	PrimaLine 7	0.48 x 0.48 x 0.29 in.
AL-01-02-9900-UD	PrimaLine 3	0.4 x 0.48 x 0.29 in.	AL-01-79-9900-UD	Varien 1.2 XT	0.56 x 0.48 x 0.29 in.
AL-01-51-9900-UD	PrimaLine 3 SE	0.4 x 0.48 x 0.29 in.	AL-01-80-9900-UD	Varien 2.7	0.56 x 0.48 x 0.29 in.
AL-01-04-9900-UD	PrimaLine 1.5 XT	0.56 x 0.48 x 0.29 in.	AL-01-81-9900-UD	Varien 5.5	0.56 x 0.48 x 0.29 in.
AL-01-05-9900-UD	PrimaLine 3 XT	0.56 x 0.48 x 0.29 in.	AL-01-82-9900-UD	Varien 8	0.56 x 0.48 x 0.29 in.
AL-01-07-9900-UD	PrimaLine 5.5 LP	0.48 x 0.48 x 0.29 in.			
AL-01-08-9900-UD	PrimaLine 2.7 LP	0.48 x 0.48 x 0.29 in.			
AL-01-15-9900-UD	PrimaLine 4.4 Gen 2	0.48 x 0.48 x 0.29 in.			
AL-01-16-9900-UD	PrimaLine 4.4 XT Gen 2	0.48 x 0.48 x 0.29 in.			

## INSTRUCTIONS

NOTE: Check polarity of the tape light and/or wires: (+) and (-) symbols on the tape should match POSITIVE (red) and NEGATIVE (black) wires.  
 NOTE: Ensure all components are installed in accordance with the current National Electric Code (NEC), and UL safety standards.

### Connecting Standard Tape Light

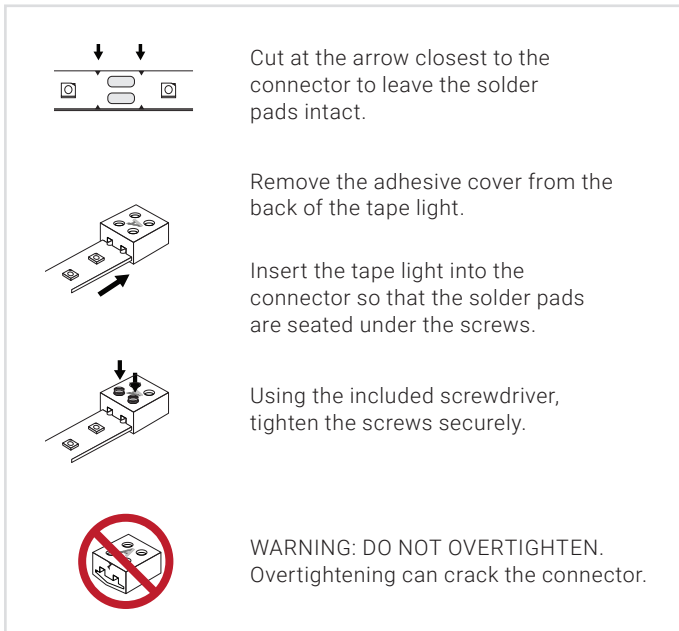

Cut at the arrow closest to the connector to leave the solder pads intact.

Remove the adhesive cover from the back of the tape light.

Insert the tape light into the connector so that the solder pads are seated under the screws.

Using the included screwdriver, tighten the screws securely.

**WARNING: DO NOT OVERTIGHTEN.** Overtightening can crack the connector.

### Connecting Low-Profile Tape Lights

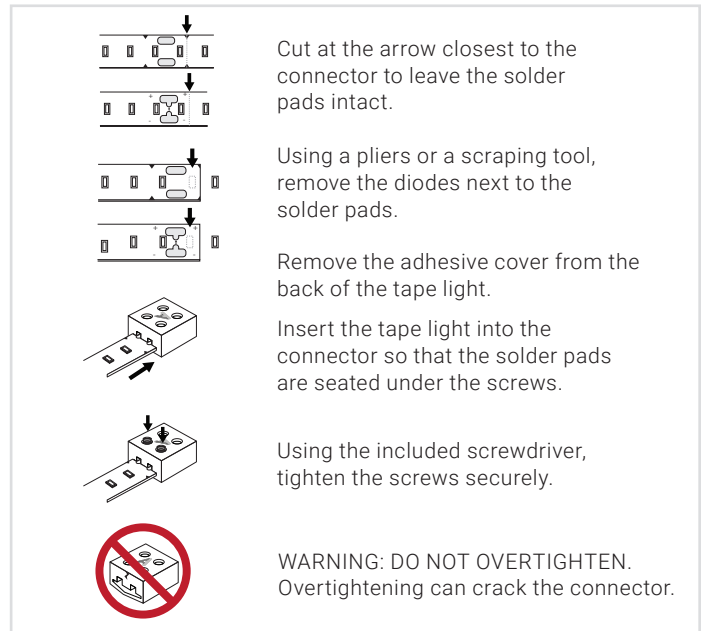

Cut at the arrow closest to the connector to leave the solder pads intact.

Using a pliers or a scraping tool, remove the diodes next to the solder pads.

Remove the adhesive cover from the back of the tape light.

Insert the tape light into the connector so that the solder pads are seated under the screws.

Using the included screwdriver, tighten the screws securely.

**WARNING: DO NOT OVERTIGHTEN.** Overtightening can crack the connector.

### Connecting Wire

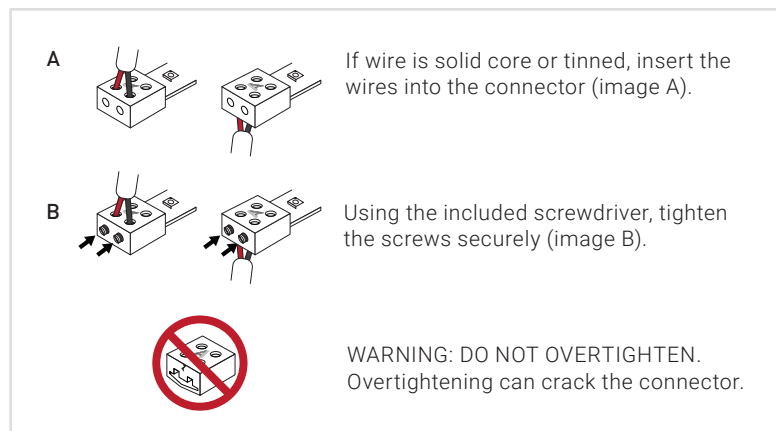

**A** If wire is solid core or tinned, insert the wires into the connector (image A).

**B** Using the included screwdriver, tighten the screws securely (image B).

**WARNING: DO NOT OVERTIGHTEN.** Overtightening can crack the connector.

## CONFIGURATIONS

### Down Connection

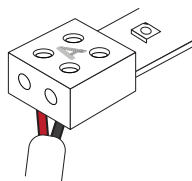

### Up Connection

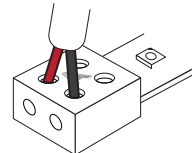

## AMP CHAMP & CHANNEL COMPATIBILITY

	Polymer Low-Profile Surface Mount	Surfa 1	Surfa 2	Surfa 2X	Surfa 3	Surfa 6	Surfa 7	Suspan® 1	Ankr® 1	Ankr® 2	Ankr® 3	Ankr® 4	Naro® 4	Duro 1	Duro 2
PrimaLine® 1.5	Y		Y	Y		Y	Y	Y	Y	Y	Y	Y	Y	Y	Y
PrimaLine 1.5 XT	Y			Y				Y	Y	Y					
PrimaLine 2.7 LP	Y			Y		Y	Y	Y	Y	Y	Y	Y	Y		
PrimaLine 3	Y		Y	Y		Y	Y	Y	Y	Y	Y	Y	Y	Y	Y
PrimaLine 3 XT	Y			Y				Y	Y	Y					
PrimaLine 4.4 Gen 2	Y			Y		Y	Y	Y	Y	Y	Y	Y	Y		
PrimaLine 4.4 XT Gen 2	Y			Y		Y	Y	Y	Y	Y	Y	Y	Y		
PrimaLine 5.5 LP	Y			Y		Y	Y	Y	Y	Y	Y	Y	Y		
PrimaLine 7	Y			Y		Y	Y	Y	Y	Y	Y	Y	Y		
Varien 1.2 XT Dim-to-Warm	Y			Y				Y	Y	Y					
Varien 2.7 Dim-to-Warm	Y			Y				Y	Y	Y					
Varien 5.5 Dim-to-Warm	Y			Y				Y	Y	Y					
Varien 8 Dim-to-Warm	Y			Y				Y	Y	Y					

Amp Champ Up/Down can either be positioned outside of a channel or be positioned inside a channel. If mounting inside of a channel, be sure to pre-drill a hole for the wires to thread through. Diagram of Amp Champ Up/Down inside a channel shown below.

**Outside Channel**

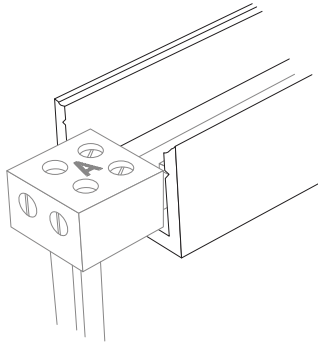

**Inside Channel**

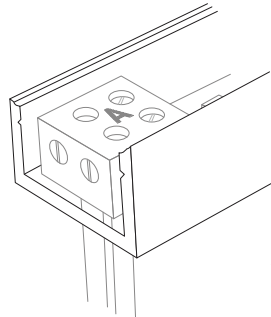

**Amp Champ**

- 0.56 x 0.48 x 0.29 in.
- 0.48 x 0.48 x 0.29 in.
- 0.4 x 0.48 x 0.29 in.

**Required Drill/Hole Size**

- 3/8 in. hole
- 5/16 in. hole
- 5/16 in. hole

Channel with hole drilled in channel for the wires to thread through.